

estelon

from Alfred & Partners

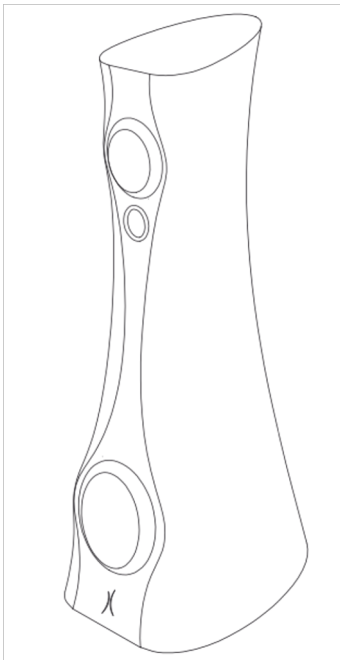

*Designed
by Alfred Vassilkov*

Model X Diamond Mk II

Serial Number _____

Your ESTELON loudspeakers have passed our quality control:

– Technical test passed.

Marek Rajatalu

Production Manager Estelon

– Listening test passed.

Alfred Vassilkov
Head of Research and Development,

Alfred & Partners

Table of Contents

1. INTRODUCTION	4
1.1. ALFRED & PARTNERS OÜ	4
1.2. ESTELON X DIAMOND Mk II	6
1.2.1. Cabinet Design.....	7
1.2.2. Transducers.....	8
1.2.3. Crossovers	10
1.2.4. Finish.....	11
2. SPECIFICATIONS	12
3. UNPACKING INSTRUCTIONS.....	13
4. SET-UP	17
4.1. INITIAL POSITIONING IN THE ROOM	17
4.2. INSTALLING THE BASES.....	18
4.3. WIRING	19
4.4. BREAK-IN PERIOD	19
4.5. SET-UP RECOMMENDATIONS BY ALFRED VASSILKOV	20
5. TAKING CARE OF YOUR ESTELON SPEAKERS.....	21
6. ESTELON / ALFRED & PARTNERS OÜ – TECHNICAL SERVICES.....	22

1. INTRODUCTION

1.1. Alfred & Partners OÜ

Alfred & Partners, the Tallinn-based design studio, think-tank, and owner of Estelon, is not simply a business but a passionate dedication to a single, heartfelt idea: the development and manufacturing of instruments capable of unveiling the rich, emotional tapestry of music in a personally involving and captivating way.

For more than 35 years Electro-acoustics Engineer and company founder, Alfred Vassilkov, has been relentlessly designing loudspeakers. His designs have been awarded numerous patents while also achieving much success in Europe. In 2010 a decision was made: to establish his own brand based on his extensive experience, knowledge, and relentless passion.



Alfred Vassilkov, the Designer and Founder of Estelon

Such dedication carries the implicit responsibility of a wholly uncompromising approach to audio design. Pride of craftsmanship shares equal footing with sonic innovation. Alfred Vassilkov's visionary achievements along with his tireless drive and quest for musical truth created an innovative brand of loudspeakers whose products offer unrivalled musicality and incomparable beauty: Estelon. More importantly, Estelon offers a distinctive key that assists listeners in unlocking the vast structure of emotion through music.

For the Estelon brand, the visionary development started in 2006 when Alfred started analyzing materials and technologies for producing cabinets with streamlined shapes that could not only reproduce the best sound but also assimilate into home interiors with an elegant, sculptured look. Years of research and development led him to a proprietary, crushed marble-based composite. The material, having excellent stiffness and anti-resonant attributes, as well as various technical advantages, allows the creation of molded cabinets with a purposeful design that enhances the sound quality of the entire audio system. Estelon's unique E-lon® shape creates the ideal conditions for sound reproduction. Its curved, smooth form eliminates corner reflections. A sculpted narrowing of the area where high frequency emanates helps achieve 0 degrees phase at the listening position, while the cabinet's larger radiuses create controlled directivity of the propagating soundwaves. The cabinet then becomes wider and deeper at its base for both stability and to allow effective low-frequency reproduction.

Every loudspeaker produced must pass Alfred & Partners' extreme level of quality control. Each pair of loudspeakers is completely hand-built, painted, assembled, tuned, tested, and then listened to individually. All Estelon products are meticulously handmade in Estonia, to the company's exacting standards.

1.2. Estelon X Diamond Mk II

Estelon X Diamond Mk II: The result of a culmination of knowledge and performance, trickled-down from our flagship loudspeakers and 10 years of history and experience. The X Diamond Mk II is a host of technological developments and a highly sophisticated full-range speaker.

Paramount among the physical design elements continues to be the use of the E-Ion© shape cabinet form. This form has been developed and perfected over a five-year period. Its design and construction allow it to easily couple with non-acoustically treated listening areas (i.e. normal living spaces). Our respect for the legacy Model XA and its design continues and remains a constant source of inspiration. Premium quality components in separate chambers, state-of-the-art carbon-fiber resonant control, and applied isolation technology along with top-quality dampening materials, are all contributing factors to an exhilarating audio experience.

Many years have passed since the genesis of the Estelon, and much has been learned while embodying all achievements. The roots and choices have evolved into the Estelon sound. With the X Diamond Mk II, the most beloved element of Estelon products has been reaffirmed again: simplicity. Featuring “minimalistic” second-order crossovers and the refined combination of the selected drivers and the acoustical attributes of the enclosure, has allowed Estelon to achieve their signature sound along with enhanced performance qualities.

The X Diamond Mk II is a speaker designed for larger listening rooms (suggested room size 25-80 m²) and provides exceptionally wide imaging, deep sound stage, and thrilling life-like dynamics. It is far more than speaker drivers in a cabinet. It is a genuine musical instrument in its own right, and when carefully integrated into a

system and listening space, it is capable of connecting the listener to the music in a most profound and transcending way. Everything is expressed naturally, balanced, and emotionally engaging. The X Diamond Mk II possesses an eminently musical temperament that is immediately evident upon your first audition and every subsequent listening experience.

The X Diamond Mk II will surprise the listener with the extremely defined and unexpectedly deep bass, clear and articulate mid-range, and musically detailed and dynamic high frequencies. The X Diamond Mk II is capable of reproducing the finest nuances of music.

1.2.1. Cabinet Design

Chief among the physical design elements of the X Diamond Mk II is the use of the E-Ion© cabinet form that has been developed and honed over many years of research and testing in order to find the right material that would allow the highest quality of cabinet and construction for the loudspeaker's acoustically engineered shape. The cabinet is extremely rigid, highly dense, resonant-free, and with exceptional internal dampening and acoustical control. This is the result of time-honoured construction techniques, a special casting process, the use of a proprietary marble-based composite along with the extensive use of sub-structural stiffening spars that break up resonance nodes and create an internal acoustic chamber of non-parallel sidewalls that is all but immune to unwanted standing waves that can cause a coloured sound. This is why the Estelon speakers reproduce a very natural and balanced sound. During the final hand-assembly process each speaker is individually tuned to maintain uniformity from unit to unit. Unusual in its defined form, the result of this cabinet construction allows it to be easily paired even in an

acoustically untreated room, allowing the bass to roll effortlessly into the listening space.

1.2.2. Transducers

The German-made Accuton drivers employed are the highest expression of transducer design. The 280 mm (11 inches) bass driver uses a special ultra-stiff ceramic sandwich dome with an FEA optimized underhung motor design with 55 mm titanium voice coil. The former guarantees very low energy storage and good heat transfer. The 173 mm (7 inches) quick, impactful, and accurate mid-woofer has a ceramic membrane providing ultra-fast impulse response with significantly reduced total harmonic distortion (THD) and intermodulation distortion (IMD), as well as increased frequency bandwidth and linearity. It has a sophisticated design with particular attention paid to the titanium voice coil former and the surrounding air gap which provide maximum freedom from dynamic compression in conjunction to the use of the ultra-stiff ceramic dome, which is valued for its midrange neutrality. All moving elements of the driver are ventilated for a resonance-free response. This unique technology allows the X Diamond Mk II to produce bass and dynamics that belie the size of the loudspeaker enclosure. The 25 mm (1 inch) diamond membrane tweeter can reproduce sounds at the highest frequencies, up to 60 kHz, with no distortions in the human hearing range. Diamond is the hardest known material on Earth, and not only does the diamond membrane look elegant, it also shows considerable technical and sonic advantages when compared to conventional high-frequency membranes. A thin dome of diamond would be ideal for a tweeter because the stiffness-to-weight ratio of this material is unsurpassed, nothing else even comes close. It transmits the driver

membrane's acceleration almost entirely undistorted in an exact (perfect) soundwave. The diamond tweeter's specially developed neodymium overhung motor design, with vented aluminium voice coil former, guarantees low energy storage and excellent heat transfer. That means the energy created by the musical signal is not wasted or lost in any aspect and instead flows through the membrane with lightning-fast speed, incredible dynamics, and true-to-the-source accuracy. The tweeter's soft fabric surround and high viscosity ferrofluid cooling, within the powerful magnetic circuit, keep the moving parts perfectly centered and aligned with flawless linearity.

The sonic character of the Estelon loudspeakers that feature diamond tweeters is not what you would expect: an overly "brilliant" or "hard-as-diamond" sound, which in most cases is caused by a high amount of harmonic distortion. In our loudspeakers, through the properly designed crossover, the diamond tweeters simply disappear, and only the music remains. It is like being present at a live concert where one can hear the instruments but not the speakers reproducing the sound. The Estelon Diamond loudspeakers offer a new way of relaxed listening, and you get to sense all the details that you have never heard before on your old records and digital music. You will be immersed in acoustical spaces with a "live" 3D presence that was never there before.

Each drive unit is "broken-in" by running an audio signal through them for several hours before selecting matching drivers for each pair of speakers. When the drivers are in matching pairs, another "break-in" with an audio signal is conducted. Finally, drivers are fitted into the finished cabinet for individual tuning.

1.2.3. Crossovers

The crossovers are mounted in a special isolated chamber to reduce the microphonic effect and vibration influence. Each crossover construction process involves careful attention from our engineers and designers, where every process is carefully measured, and each component is tested to make sure that the final outcome is perfect. In addition to technical measurements, there is also a final listening and evaluation process done by our highly experienced engineers.

The Estelon X Diamond Mk II has a finely tuned crossover. It is in second-order, allowing it to be incredibly fast and with perfect phase transition. The crossover point of the tweeter and mid-woofer is at 2.5 kHz and between the mid-woofer and woofer at 80Hz.

We use custom transformer-core coils, OFC (oxygen-free copper) foil coils, Mundorf Silver-Gold-Oil capacitors and Carbon-Silver resistors, Duelund Silver Graphite resistors (on mids and highs), and all of which are measured to extremely tight tolerances before using in the crossover production. To maintain the smallest of details in the audio signal, direct mounting techniques are used with hand-soldered connections with short cable runs to each respective driver and binding posts. All internal cabling is of the highest quality and from the renowned cable manufacturer Kubala-Sosna. The connectors are strong and stable and are provided by Furutech.

1.2.4. Finish

Just as in the making of a great musical instrument, the finish has also an influence on the outcome. Because of the highly sophisticated cabinet shape, all the processes in the finishing stage are hand-made with extreme care by highly experienced specialists using the best technology and procedures. After casting the proprietary marble-based composite, it is allowed to age. Then the preparation of the surface of the cabinet commences by hand sanding and by sealing layer upon layer through an elaborate and time-consuming procedure. Finally, the multiple coats of the lacquer finish are applied along with the final polishing to a mirror-like finish. The Estelon X Diamond Mk II is offered in a choice of liquid gloss, matte, or the optional premium finishes.

2. SPECIFICATIONS

TYPE:	Passive speaker, Bass Reflex
DRIVERS:	
Woofer:	280 mm (11 inches) Accuton, ceramic sandwich dome
Mid-woofer:	173 mm (7 inches) Accuton, ceramic membrane
Tweeter:	25 mm (1 inch) Accuton, diamond inverted dome
INTERNAL WIRING:	Kubala-Sosna pure copper
FREQUENCY RESPONSE:	22-60 000 Hz
POWER RATING:	200 Watts
NOMINAL IMPEDANCE:	6 ohms (min 3.5 ohms at 50 Hz)
SENSITIVITY:	88 dB / 2.83 V
MINIMAL AMPLIFIER POWER:	20 Watts
DIMENSIONS:	Height: 1370 mm (54 inches) Width: 450 mm (17.7 inches) Depth: 640 mm (25.1 inches)
NET WEIGHT:	86 kg (189.6 lbs) per piece
SHIPPING WEIGHT:	141 kg (310.8 lbs) per piece

3. UNPACKING INSTRUCTIONS

The packaging is precisely thought-through so despite the weight of 86 kg of each speaker, they can be quickly and safely transported to their final position in the room. The transport cases (industrial grade custom flight-cases) and the speakers themselves are equipped with wheels to ease the transportation and setup. The speaker wheels can be easily replaced by the designated special floor spikes or flat bases once the ideal placement and positioning have been determined.

Your Estelon loudspeakers come packaged individually in 2 separate flight cases. We recommend keeping these cases for possible future transportation. Due to the substantial weight and slippery surface of the loudspeakers, we suggest that two able-bodied individuals assist in the unpacking and positioning process.

Contents of the two flight cases:

- 2 loudspeakers
- 1 Accessories box:
 - 2 sets of isolation metal bases (8 pieces)
 - 2 sets of spikes (8 pieces)
 - 2 sets of flat feet (8 pieces)
 - 1 user's manual
 - 2 pairs of gloves
 - 1 polishing cloth

For unpacking, please follow the instructions described below and as shown in the drawings.

1. Unlock/open all four locks of the flight case cover while the speaker/flight case is in a horizontal position. (drawing 1)
2. Carefully lift and remove the cover from the flight case. (drawing 2)
3. Remove the foam plate from the speaker's bottom as shown in drawing 3.
4. Lift gently the flight case as shown in drawing 4 while the other person supports the speaker from the other side.
5. Lift the flight case with the speaker to a vertical position as shown in drawing 5.

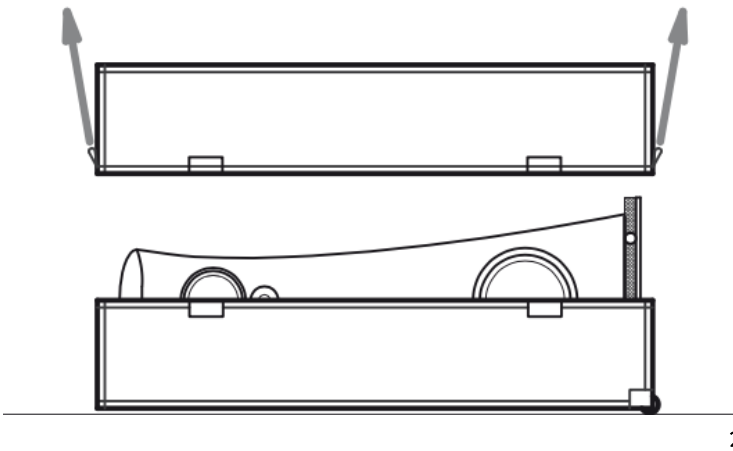
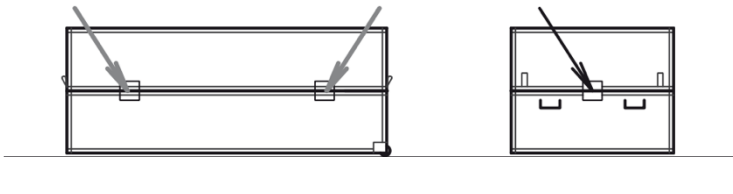

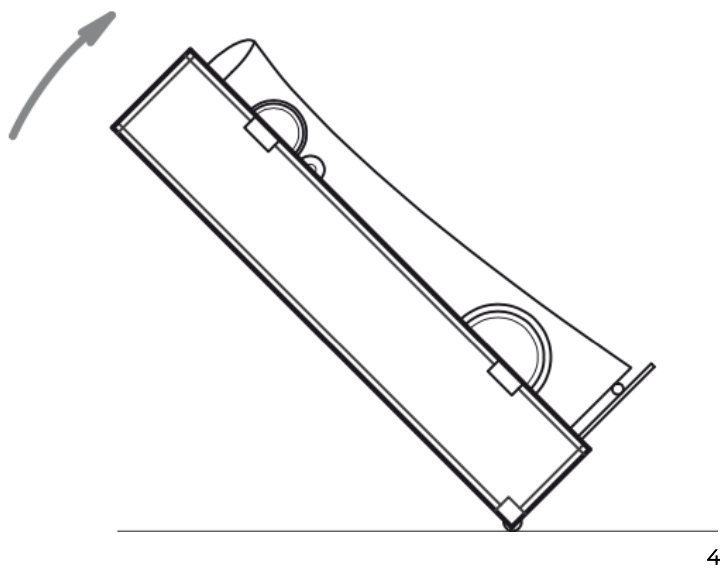
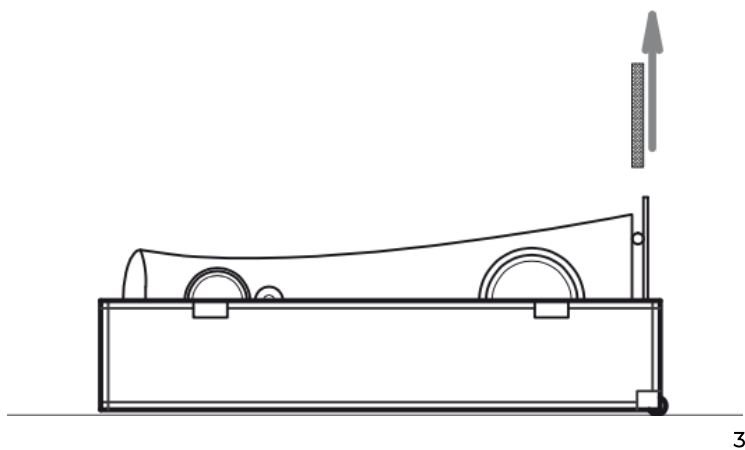

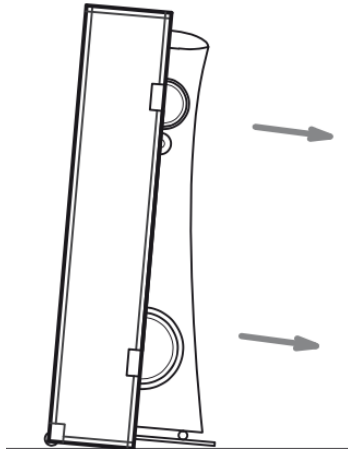

5

6. When in an upright position, support the speaker while rolling it out of the case slowly. Please use the provided gloves that are included in the accessories box inside the flight case.
7. Now, with the speaker upright and out of the flight case, roll it to the desired position in your room and then carefully remove the cloth bag. We recommend keeping the speakers on wheels during the initial set-up.
8. Once the final position has been located, it is time to replace the transport wheels with the enclosed spikes as shown in drawing 6 by replacing the wheels on one side of each loudspeaker at a time. One person should carefully tilt the speaker against himself/herself and hold it in this position while the other person removes the two wheels and inserts the enclosed spikes into the holes next to the holes of the transport wheels. Please make sure the edge of the speaker's bottom does not touch the floor during this process.

Repeat the process for replacing the rest of the wheels on that loudspeaker, and then repeat this process for the other loudspeaker. After both loudspeakers are standing on their spikes, please save the wheels in the event of future transportation.

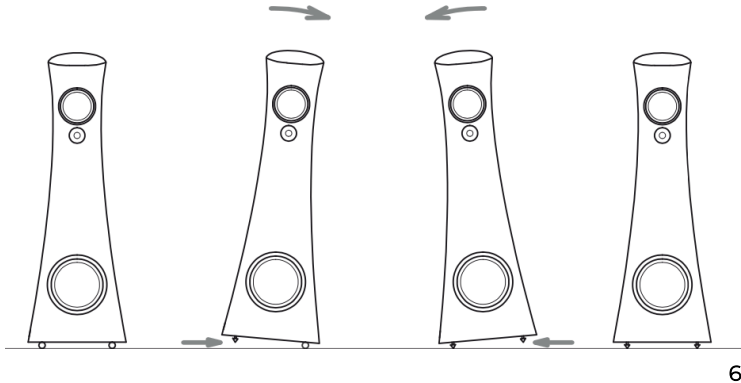

4. SET-UP

4.1. Initial positioning in the room

Model X Diamond Mk II – Suggested room size 25-80 m²

When positioning the speakers in your room, it is advised to allow enough "free" space around the speakers to minimize sound reflections from walls, furniture, etc. This will contribute to achieving correct tonality, realistic imaging, focus, and dynamics. The recommended minimum distance between the speaker and the nearest reflection point is 1.2 m (3.6 ft). The distance between the back

wall and the speaker should be no less than 0.6 m (1.8 ft). The distance of the tweeter to the back and side walls should not be the same.

Listening point: the distance between the floor and your ears should be approx. 1 m (3 ft), while the distance between the listener and the speakers should be similar to the distance between the two speakers.

The positioning of the speakers in the room must be symmetrical for achieving a balanced sound stage. This is particularly important in a narrow space. The distance between the speakers should be approx. 2.5 – 4 m (8.2 – 13 ft), depending on the size of the room and its reverberation characteristics. The recommended speaker's direction is approx. 7°, off-axis, towards the listening position (depending on the room acoustics).

Please contact your dealer for consultation on how to improve your room acoustics.

4.2. Installing the bases

Depending on the type of the floor in the listening room, there are 2 options for the stabilization of the speaker. These are required in order to achieve mechanical grounding (spikes) or vibration isolation (feet). For hard surfaces please use the isolation feet, and when placing on carpeted floors use the spikes in order to pierce through the carpet to the hard flooring underneath. Proper use of the spikes and isolation feet will achieve proper audio reproduction with fast and deep bass, focused imaging, and avoiding colouration in the midrange frequencies.

In case of an uneven floor please slightly unscrew the isolation feet that do not touch the floor. It is recommended to unscrew the 2

“free” diagonally positioned isolation feet with the same amount of “turns” in order to achieve good stability and a properly levelled loudspeaker.

4.3. Wiring

When connecting the speaker to the amplifier please make sure that the amplifier is in the off position. Connect the speaker cable to the pole terminal on the back of the speaker: speaker terminal „+“ with the amplifier terminal „+“ and „-“ with „-“. For signal flow, please follow the direction marked on the cable or in the cable manufacturer’s instruction. Typically, the signal flow is in the same direction as the labelling/writing on the cable.

4.4. Break-in period

Although all Estelon speakers have an initial “break-in” at the factory, due to shipping conditions and pressure/temperature changes that may have incurred, the speakers will need to go through an additional “break-in” process before their final set-up. All the mechanical and electrical connections will stabilize naturally after playing a continuous music signal for approx. 24 hours – e.g. use a digital source on repeat mode. After the initial “break-in” period, you can start setting-up the sound according to Alfred Vassilkov’s recommendations. Please note that the speakers should reach their optimum level of performance after about 300-400 hours of use.

4.5. Set-up recommendations by Alfred Vassilkov

The set-up of the sound consists of the balance between different parameters such as tonality, bass accuracy, focus, stage imaging, depth, etc. The time required for this process depends on the listener's experience and skills. Proper set-up will maximize the speakers' performance. During the final set-up, small adjustments may be made to the initial chosen position, e.g. moving the speakers 10 cm towards the front wall, etc. Please evaluate the sound carefully every time you make a small change in the positioning. Continue making small changes in the positioning and evaluate again until the proper position with a balanced, natural sound is found. We suggest that you test and listen to various musical pieces from different genres to avoid specific sonic accents.

Please keep in mind when changing the position of your speakers:

- Close proximity to the back wall and corners will reinforce, enhance, the bass performance.
- A shorter distance between the two speakers will create better focus and deeper imaging but will reduce the width of the stereo image.
- Pointing the speakers inwards minimizes reflections from the side walls but has an impact on the stereo image.

Once you have located the ideal position, replace the wheels with the spiked cones or isolation feet that are included in the case. Before critical listening, please allow 60-90 minutes of playback for system-stabilization. When listening at an excessive volume you risk damaging the drivers.

5. TAKING CARE OF YOUR ESTELON SPEAKERS

The multi-coated finish applied to Estelon speakers is considered the most advanced automotive finish available. It is extremely strong and durable. In order to maintain the speakers' immaculate appearance, special cleaning cloths are provided with your Estelon loudspeakers. Please note that only dry cleaning is allowed. Do not wash the speakers. In case of a smudge/spot, please use a damp, soft, lint-free cloth to clean the smudges before the final finishing with the special cloths that accompany the speakers. For the Liquid Gloss finish, please use only the polishing cloth included in the flight case. Please do not apply polishing to the speaker drivers. The use of other materials can damage, scratch, or destroy the finish.

Additional information regarding the polishing cloths and other products:

For all finishes:

- Use with the provided microfiber cloth: Würth Active Glass Cleaner (Item # 089025) Silicone-free
- 3M Perfect-It III High Performance Polishing Cloth (Item # 50486) or any 3M Microfiber cloths

For Liquid Gloss finish only:

- Window Cleaner (with alcohol)
- Polish cloth impregnated with Krytox® (DO NOT USE FOR MATTE FINISH)

No additional wax or polish is required.

For additional information and guidance regarding cleaning/polishing materials, please contact your dealer or distributor.

6. ESTELON / ALFRED & PARTNERS OÜ – Technical Services

Alfred & Partners OÜ Five Year Limited Warranty

Terms and Conditions

1. Limited Warranty – All ESTELON products purchased from authorized ESTELON dealers are covered by a limited 5-year non-transferrable warranty granted by Alfred & Partners OÜ. This warranty includes all parts and labour charges as well as return shipping charges (product owner is responsible for all shipping and insurance charges one-way to the ESTELON repair facility or ESTELON factory approved repair facility).

Upon receipt of an online registration, Alfred & Partners OÜ warrants the purchased product to be free from manufacturing, materials, and workmanship defects for **five years** from the date of original purchase, subject to the following conditions. **Failure to register the ESTELON product within 30 days from the original purchase will result in a warranty period of 90 days from the date of purchase.**

Customers should consult with their original ESTELON dealer or distributor for possible alternate repair instructions prior to contacting the ESTELON factory. Other ESTELON dealers or distributors may refuse from assisting the Customer under the limited warranty. BUT under any and all circumstances customers are welcome to contact our sales department, listed on our website www.estelon.com, for service assistance.

This limited warranty is valid only in the country where the product was originally purchased. If the repair request that is covered under this warranty comes from another country, then Alfred &

Partners OÜ may request the Customer to compensate Alfred & Partners OÜ additional costs arising from providing this limited warranty in another country than the country of original purchase.

This limited warranty shall not affect the statutory rights of the Customer.

2. Limited to Original Purchaser – This warranty is for the sole benefit of the original purchaser of the covered product and may not be transferred to a subsequent purchaser of the product.

3. Conditions and Limitations – This warranty is subject to certain conditions and limitations, as follows. This warranty is void and inapplicable if the product has not been used in accordance with the instructions found elsewhere in the owner's manual, or if it has been misused or abused, damaged by accident or neglect, or in transport once in possession of the purchaser. The warranty is also deemed void if the product has been repaired, modified, or tampered with by anyone other than Alfred & Partners OÜ or its specifically authorized agents. Please Note – if the fasteners to the cover of the crossover area, those covered with multi-coloured specialty epoxy seal, have been tampered with / the epoxy removed – the warranty will be considered to be void.

This warranty does not cover defects due to accidents or similar causes arising after the risk for the product has passed to the Customer, or normal deterioration, wear and tear.

4. Remedy – If this product contains a material, manufacturing, or workmanship defect that cannot be repaired at the dealership where the product was purchased, it must be packed in original packaging and returned to Alfred & Partners OÜ via insured freight, at the owner's expense. If replacement packaging materials are required,

they may be purchased from the factory at a charge. **Returned products must be accompanied by a written description of the defect, and a return authorization number (available from the factory via phone or email).**

Upon receipt of a defective product, Alfred & Partners OÜ agrees to repair the product without charge for parts or labour. The product will then be returned via prepaid, insured freight, with the carrier at the sole determination of Alfred & Partners OÜ. This constitutes the purchaser's sole remedy.

Alfred & Partners OÜ undertakes during the warranty period to the exclusion of any other remedy to repair or replace the part of the product, which the examination by Alfred & Partners OÜ shows to have been defective. The warranty period for repaired or replaced parts shall not exceed the original warranty period and shall terminate along with the original warranty. The term of the original warranty shall not be extended by the duration of any warranty repairs.

5. Design Changes – ESTELON reserves the right to modify its products or change specifications at any time without obligation or liability to previous purchasers.

6. Miscellaneous – This warranty does not extend to any incidental or consequential costs or damages to the purchaser. This warranty gives you specific legal rights. You may also have other rights which vary from country to country.

Instructions for Obtaining Repair Service

1. Complete the Return Authorization Request Form – available online at estelon.com/support.
2. Upon clicking the 'Submit' button on the Return Authorization Form, the ESTELON factory will review it for completeness and return an e-mail to you with an RA number when required (please allow 2-5 days for a return e-mail).
3. Crate and/or package the product **in its ORIGINAL FLIGHT CASE CONTAINERS ONLY**, according to the instructions included in the return e-mail, and ship the product to the shipping address included in the e-mail. The owner is responsible for paying the shipping and insurance charges (Alfred & Partners OÜ will cover return shipping and insurance charges on warranty repairs).
4. **In the case of non-warranty repairs**, Alfred & Partners OÜ will physically inspect the product and contact the customer for repair approval. Upon approval and completion of the repair, the product owner will be informed of the final charges (including return shipping). Payment may be made by bank/wire transfer prior to the final shipment). Payments not received within 30 days of initial contact may incur storage fees.

We strongly recommend that all product repairs should be conducted through the ESTELON factory or an authorized ESTELON repair facility. ESTELON products are designed and manufactured to the highest tolerances with numerous hand-picked components; for this reason, we HIGHLY RECOMMEND that components not be serviced by non-authorized repair facilities. Alfred & Partners OÜ values its loyal customers and will make every attempt to return repaired products to their original factory specifications. Customers should consult with their original ESTELON dealer or distributor for possible

alternate repair instructions prior to contacting the ESTELON factory. BUT under any and all circumstances customers are welcome to contact our sales department, as listed on our website www.estelon.com, for service assistance. All non-warranty repairs are warranted for one year from the date of the return shipment.

*Have we answered all your questions?
If not, please send us an email with your questions at
sales@estelon.com*

www.estelon.com

ESTELON is a trademark of Alfred & Partners OÜ

Alfred & Partners OÜ

Kukermiidi 6

Tallinn, 11216

Estonia

Notes